

Article number: 0101083
 Description: Retaining ring A 72 DIN 471
 Spring steel
 Note: Fitted with ZGA pilers

Measures

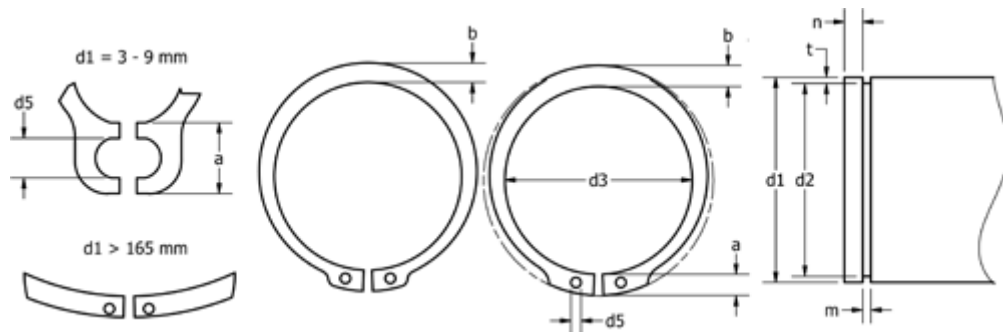

a max	= 8.2	FN kN	= 55.3	s	= 2.50
AN mm ²	= 332.0	FRg kN	= 22.80	t	= 1.50
b	= 6.8	FR kN	= 131.00	tol	= -0.30
d1	= 72	g	= 2.5	tol	= -0.07
d2	= 69.0	K kN-mm	= 236.00	tol	= +0,46-1,10
d3	= 67.5	m min	= 2.65	Tong	= ZGA-3
d5 min	= 3.0	n abl x 1000	= 6.0	Weight kg/1000	= 22.500
Description	= A72	Nominal drive	= 4.5		